

# Joinery by Bears.

## The Wave Vanity

---

### FEATURES INCLUDE:

---

- + Premium Hardwood Structure
- + Soft Closure Mechanism
- + Full body 2 PAC Paint
- + Carrara Marble Stone Top
- + White Ceramic Undermount Basin
- + Open Shelf Storage Space



# Joinery by Bears.



## CABINET COLOUR:

+ Classic White 

+ Pearl Grey 

+ Sandy 

## The Wave Vanity 900

### BASIN (Sell separately):

### HARDWARE:

+ Blum runner & hinge

### STONE COLOUR:

+ Blanco Stop Top

(Silica free)

### CUSTOMISE STONE/COLOR

+ Price to be quoted

### INQUIRIES:

+ hello@joinerybears.com

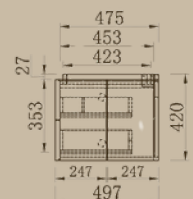
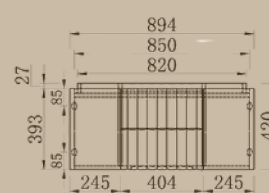
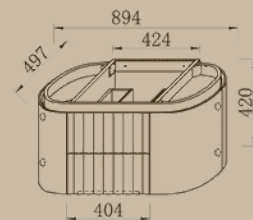
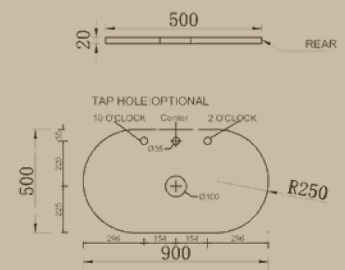
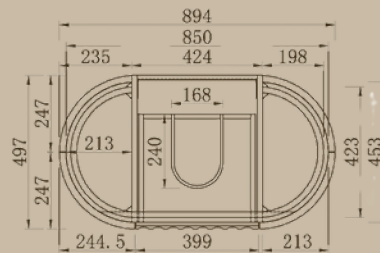

### CONSTRUCTION:

- + Door Front: High-density moisture-resistant particle board (MDF)
- + Drawer Front: High-density moisture-resistant particle board (MDF)
- + Interior: Premium Plywood
- + Hardware: Blum Soft close Mechanisms

### INSTALLATION:

- + Wall hung, assembled vanity cabinet, no assembly needed.
- + The vanity unit must be fixed to the wall by qualified tradesmen.
- + Plumbing fixtures must be installed by a qualified plumber.
- + Stone Top requires 1-2 people to lift the top to fit in cabinet.
- + Silicon top and sides of vanity if necessary.
- + No Tap hole unless requested.
- (Failure to do so will void the warranty)

Full installation guide: [Click Here](#)

### PACKAGE:

- + Vanity 32KG 980\*580\*480 mm
- + Stone 24KG 1000\*600\*100mm

### STRUCTURE:

- 1 x cutout drawer
- 1 x full-size drawer
- 2 x Doors with adjustable shelf

# Joinery by Bears.

## CABINET COLOUR:

+ Classic White 

+ Pearl Grey 

+ Sandy 

## The Wave Vanity 1200

BASIN (Sell separately):

HARDWARE:

+ Blum runner & hinge

STONE COLOUR:

+ Blanco Stop Top

(Silica free)

CUSTOMISE STONE/COLOR

+ Price to be quoted

INQUIRIES:

+ hello@joinerybears.com

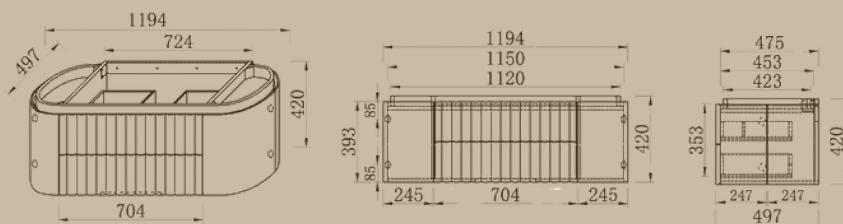
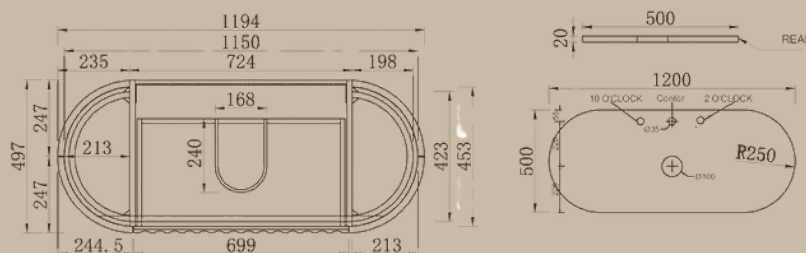

CONSTRUCTION:

- + Door Front: High-density moisture-resistant particle board (MDF)
- + Drawer Front: High-density moisture-resistant particle board (MDF)
- + Interior: Premium Plywood
- + Hardware: Blum Soft close Mechanisms

INSTALLATION:

- + Wall hung, assembled vanity cabinet, no assembly needed.
  - + The vanity unit must be fixed to the wall by qualified tradesmen.
  - + Plumbing fixtures must be installed by a qualified plumber.
  - + Stone Top requires 1-2 people to lift the top to fit in cabinet.
  - + Silicon top and sides of vanity if necessary.
  - + No Tap hole unless requested.
- (Failure to do so will void the warranty)

Full installation guide: [Click Here](#)

PACKAGE:

- + Vanity 39KG 1280\*580\*480 mm
- + Stone 32KG 1300\*600\*100mm

STRUCTURE:

- 1 x cutout drawer
- 1 x full-size drawer
- 2 x Doors with adjustable shelf

# Joinery by Bears.

## CABINET COLOUR:

+ Classic White 

+ Pearl Grey 

+ Sandy 

## The Wave Vanity 1500 Double

### BASIN (Sell separately):

### HARDWARE:

+ Blum runner & hinge

### STONE COLOUR:

+ Blanco Stop Top

(Silica free)

### CUSTOMISE STONE/COLOR

+ Price to be quoted

### INQUIRIES:

+ hello@joinerybears.com

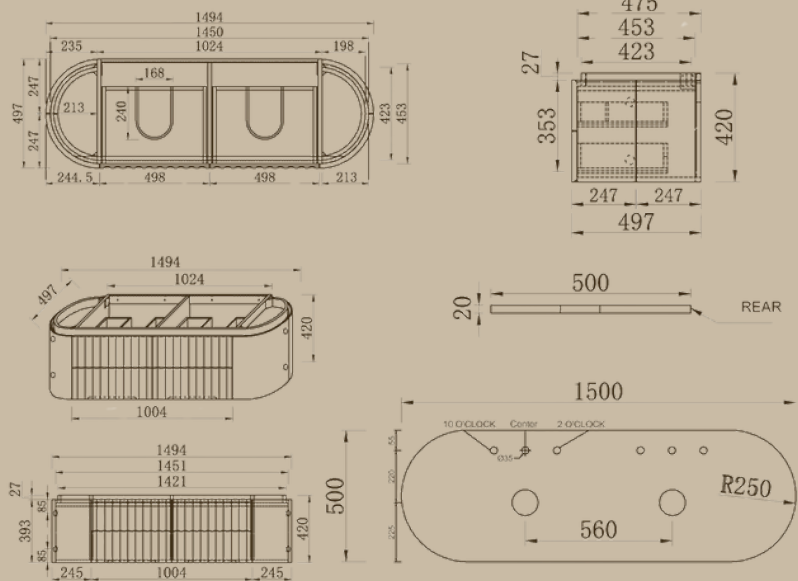

### CONSTRUCTION:

- + Door Front: High-density moisture-resistant particle board (MDF)
- + Drawer Front: High-density moisture-resistant particle board (MDF)
- + Interior: Premium Plywood
- + Hardware: Blum Soft close Mechanisms

### INSTALLATION:

- + Wall hung, assembled vanity cabinet, no assembly needed.
- + The vanity unit must be fixed to the wall by qualified tradesmen.
- + Plumbing fixtures must be installed by a qualified plumber.
- + Stone Top requires 1-2 people to lift the top to fit in cabinet.
- + Silicon top and sides of vanity if necessary.
- + No Tap hole unless requested.
- (Failure to do so will void the warranty)

Full installation guide: [Click Here](#)

### PACKAGE:

- + Vanity 52KG 1580\*580\*480 mm
- + Stone 39KG 1600\*600\*100mm

### STRUCTURE:

- 2 x cutout drawer
- 2 x full-size drawer
- 2 x Doors with adjustable shelf

# Vanity Cabinet Cleaning Care Guide

---

Congratulations on your new vanity cabinet! To ensure its beauty and functionality last for years, please follow these care and cleaning instructions:

## Regular Cleaning:

### 1. Dusting:

- + Use a soft, dry cloth to dust the surface regularly.
- + Avoid using rough or abrasive cloths that may scratch the finish.

### 2. General Cleaning:

- + Wipe down the surface with a damp, soft cloth.
- + Use a mild soap or detergent if needed. Dilute the soap in water and apply with a cloth.
- + Immediately dry the surface with a clean, soft towel to prevent water spots and moisture damage.

## Deep Cleaning:

### 1. Stubborn Stains:

- + For tougher stains, use a mixture of water and a small amount of mild dish soap.
- + Apply the solution to the stain with a soft cloth, gently rubbing in a circular motion.
- + Rinse the area with a damp cloth and dry thoroughly.

### 2. Hardware Cleaning:

- + Use a damp cloth to wipe down handles and other hardware.
- + For brass handles, you may use a brass cleaner but ensure it doesn't come into contact with the cabinet surface.

## Specific Material Care:

### 1. Painted Surfaces:

- + Avoid harsh chemicals or abrasive cleaners that can damage the paint.
- + Use a mild, non-abrasive cleaner diluted with water.

### 2. Marble Countertop (if applicable):

- + Clean spills immediately to avoid staining.
- + Use a pH-neutral cleaner specifically designed for marble.
- + Avoid acidic or abrasive cleaners that can etch the surface.

## Preventative Care:

### 1. Avoid Excessive Moisture:

- + Do not allow water or other liquids to sit on the surface for extended periods.
- + Always wipe up spills immediately to prevent damage.

### 2. Heat Protection:

- + Avoid placing hot items directly on the vanity surface. Use trivets or heat pads to protect the finish.

### 3. Use Gentle Cleaners:

- + Avoid using bleach, ammonia, or other harsh chemicals.
- + Opt for mild, non-abrasive cleaners designed for the specific materials of your vanity.

## Maintenance Tips:

### 1. Regular Inspections:

- + Periodically check for any signs of damage or wear and address them promptly.
- + Tighten any loose hardware to maintain the integrity of the cabinet.

### 2. Protective Coating:

- + Consider applying a protective wax or sealant to the surface to enhance durability and shine.
- + Follow the manufacturer's instructions for any products used.

By following these care instructions, you can ensure that your vanity cabinet remains beautiful and functional for many years.

Thank you for choosing our product!

For any further questions or assistance, please contact our customer service team at:

+ Email: [hello@joinerybybears.com](mailto:hello@joinerybybears.com)

+ Phone: 0411 013 310